

Alpha IP: Room Control Unit Radio with Display

The Alpha IP Room Control Unit Radio with Display registers the room temperature and the humidity in the assigned heating zone and regulates it via connected Alpha IP Radiator Thermostats or the base station for floor temperature adjustment.

As a component of the Alpha IP building automation system, the room control unit offers access to all room and system specific parameters with its extensive functionality. The precise temperature registration allows to establish a perfectly matched room-by-room temperature control system for maximum user comfort.

The Alpha IP app allows to adapt heating phases to individual user requirements. Operation is performed via a rotary control with rotary-push action and fine ratchet as well as by the language-neutral indication of the high-quality display which is always well visible, or also using the Alpha IP app.

Already in their standard design, the Alpha IP Room Control Unit Radio with Display persuades with a modern appearance. Customer-specific differentiation is always possible.



1.1 Features

- Flat design and small dimensions (86 mm x 86 mm x 31.9 mm)
- Self-explaining, language-neutral operation and user guidance
- Big display with white background illumination (57 mm x 33 mm)
- Display of target and actual temperature as well as humidity
- Time-controlled regulation of room temperature in connection with one or more Alpha IP Radiator Thermostats or the Alpha IP Base Station for floor heating systems
- Up to three adjustable heating profiles: The room temperature can be adjusted in a time-controlled way (up to 6 heating phases per day with individually configurable temperature)
- Cyclic data transmission to Alpha Base Station, radiator thermostats or pluggable switch
- Manual adjustment of target temperature (to the nearest 0.5 °C) directly at the control wheel
- Direct activation of the boost function (fast and short-term heating of the room in case of radiator thermostats)
- High-quality OEM design with a multitude of optical differentiation possibilities
- Wall and flush-type box installation (Germany & Switzerland)
- Automatic change over between summer and winter time
- Simultaneous coupling to 2 base stations
- Up to 8 window contacts can be assigned to the room control unit
- Compatible to Homematic IP
- Encryption and authentication of all data packets according to safety standards as e.g. AES-128 and CCM/RFC3610

The Möhlenhoff OEM product quality ensures easy, intuitive installation, operation and maintenance of the entire system.

1.2 Variants

In the respective basic version, the Alpha IP Room Control Unit Radio with Display will be delivered as neutral devices without logo and in white.

Type designation	Designation	Scope of supply
RDT 61001-N1	Room Control Unit Radio Display	<ul style="list-style-type: none"> • OEM Alpha IP: Room Control Unit Radio Display • Installation instructions in 12 languages • 2 x 1.5 V LR03/Micro/AAA batteries • 2 x power strips • 2 x screws 3.0 x 30 mm • 2 x dowels

1.3 Optional extensions or differentiations to the basic version

Extension options		
Instructions, language set 1	Detailed instructions for the room control unit can be attached to the scope of delivery of the base station in the following languages (otherwise these are available for download under www.ezr-home.de) (otherwise these are available for download under www.ezr-home.de).	German English French Dutch Italian Spanish
Instructions, language set 2	Detailed instructions for the room control unit can be attached to the scope of delivery of the base station in the following languages (otherwise these are available for download under www.ezr-home.de).	English Danish/Norwegian Finnish Swedish Polish Russian

Differentiation possibilities	
Packaging	Individual printing and manufacturing of packaging
Casing	Individual colour
Casing printing	Laser marking of the company logo on the casing, and the individual type designation and the device designation
Installation bottom	Colour adaptation
Rotary control	Individual colour adaptation
Please contact us if you have further wishes.	





2 Function

For establishing the operational readiness, generally only a pairing process via the IP system key is necessary in order to integrate into the Homematic IP network. The room control unit has pre-defined settings and parameters for an immediate operation in the Homematic IP network. Using the rotary control, numerous system functions and parameters can be individually set at the room control unit for user comfort and for energy optimisation purposes.

2.1 Operation









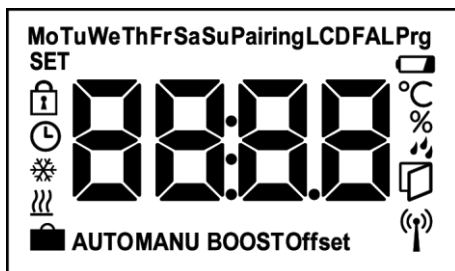



The device is operated via the rotary control. The selection menu is activated by pressing and holding the button for 3 seconds. The rotary control can be used for navigating through the menu structure of the room control unit. Turning to the left or to the right allows navigation; pressing and holding the button will select the desired menu item. The background illumination is automatically activated when operating the device.

2.2 Menu and navigation

AUTO	- Auto operating mode: The provided temperature profile is active
MANU	- Manual function: Regulation to the manually set temperature
	- Holiday function: The desired setback temperature is activated for the holiday period. (Can be used alternatively as party function: The desired party temperature is activated for the party period.)
	- Operating lock as a protection against accidental maladjustment and wrong operation. Can be activated/deactivated globally in the app and locally at the device.
Prg	- Individual programming of day profiles of heating (cooling) times (max. 6 per day in the time from 0:00 to 23:59 o'clock)
	- Setting of date & time for the overall system
Offset	- The offset function allows a temperature comparison
LCD	- Selection of LCD display: Room temperature, target temperature, room temperature and humidity alternating
FAL	- The menu item FAL allows an individual definition of the system parameters of the OEM Alpha IP Base Station for surface heating.
	- Radio test

2.3 Display: Symbols and their meaning



	Display range		Low batteries
	Weekday information		Pairing mode active, or malfunction. Connection test
SET	Target temperature input active		Time/date setting active
	Operating lock active		Window open
	Cooling mode active		Dew point mode active (in future)
	Heating mode active		Temperature display active
	Holiday function active (alternatively: party function)	FAL	System or heating zone parameters input active
AUTO	Automatic mode active	Prg	Programming mode active
MANU	Manual mode active	LCD	Selection of display mode active
BOOST	Boost function active	Pairing	Pairing mode active
Offset	Target temperature comparison active		

3 Technical Data

Type designations	RTD 61001-N1
Voltage supply	2x 1.5 V LR03/micro/AAA
Power consumption	max. 50 mA
Battery service life	2 years (typ.)
Reverse polarity protection	Mechanical
Radio technology	Radio, 868.3 and 869.525 MHz SRD band, cat. 2
Communication protocol	Homematic IP
Duty cycle	868.3 MHz < 1% per h; 869.525 MHz < 10% per h
Typical radio free-field range	250 m (in open air)
Degree of protection	IP20
Admissible ambient temperature	0 °C to 50 °C
Admissible ambient humidity	5 to 80 %, not condensing
Storage/transport temperature	-10 °C to +50 °C
Standards and regulations	2014/53/EU radio installations; 2014/30/EU EMC; 2011/65/EU ElektroG, resp. RoHS compliant
Material	ABS (casing, base, rotary control) / PMMA (disk, system button)
Colour	RAL9003 (signal white)
Exterior dimensions (W x H x D)	86 x 86 x 24.6 mm / 31.9 mm
Weight	110 g (including battery)
Visible display area	33 x 57 mm
Encoder	30 clicks on 360°
Target temperature setting range	5.0 to 30.0 °C
Target temperature resolution	0.5 K
Measuring accuracy of internal NTC	±0.5 K
Humidity measuring range	20...80%
Humidity resolution	1 %
Humidity measuring accuracy	max. ± 4.5%
Packaging dimensions	122 x 112 x 70 mm

3.1 Dimensions

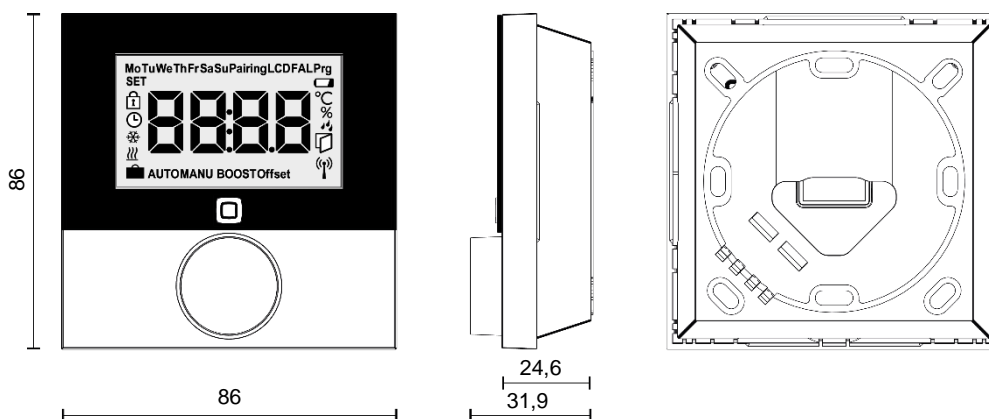

Fig. 1: Dimensions Alpha IP: Room Control Unit Radio with Display (all indications in mm)

3.2 Approvals & certificates



The CE identification documents that the products placed on the market comply with the applicable requirements of the EU Directives.



4 Installation notes

4.1 Preconditions

The safe 868 MHz radio technology of the system offers numerous advantages to users and installers as e. g. the optimum positioning of the room control units in the allocated zone without any cabling efforts. This makes annoying caulking and plastering work obsolete. At the same time, all installation conditions can be met without any problems.

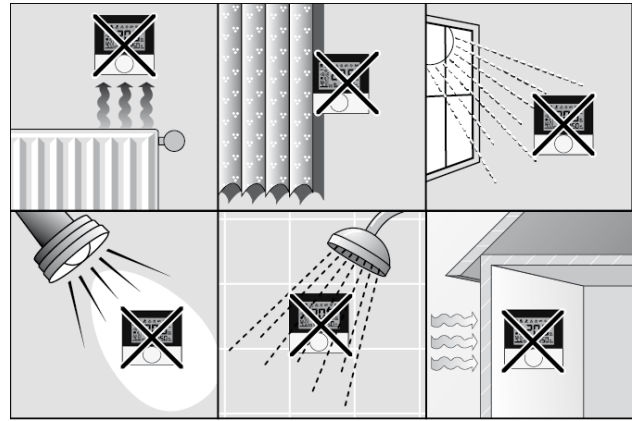
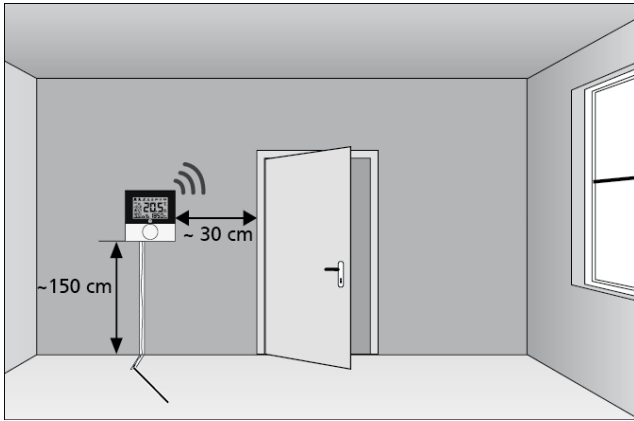

4.2 Installation

The room control units are installed comfortably on-surface, with stripes or in a flush-type box in a few simple steps.

